

PAGING DESK FOR MXA-400

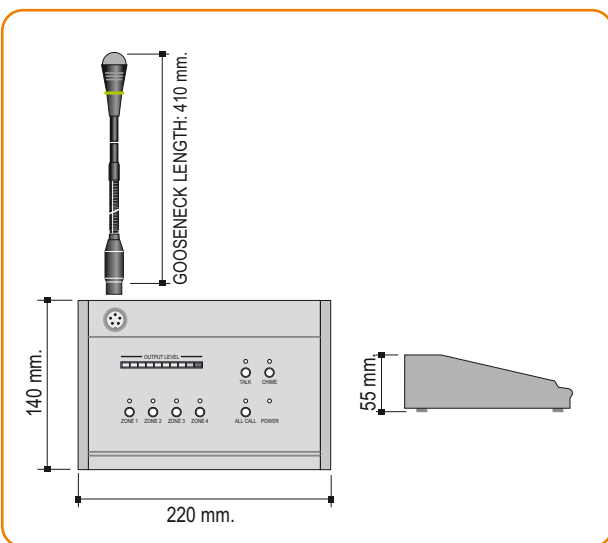
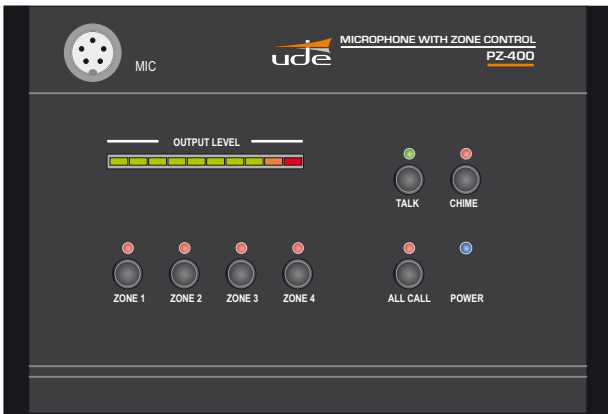

DESCRIPTION

PZ-400 is an addressable condenser paging desk, with until 4 different zone selectors and all-call key for a broadcast announcement.

The different LED indicators show the user the configuration of the paging desk: CHIME selection, zone/s selection, VU meter signal level and working status.

The MXA-400 allows until 4 paging desk in the same system with a FTP CAT-5 BUS connection between them. PZ-400 uses a bus to send data and audio, bringing durability, flexibility and easy interaction with the user.

Main characteristics:

- VU meter indicator.
- 4 zone selection keys.
- Chime option.
- Two different pre-recorded chimes (2 or 4 tones).
- Microphone, chime and master volume controls.
- Daisy-chaining up to 1000 m.
- 24Vdc (power supply included).

TECHNICAL CHARACTERISTICS

- Microphone:	Condenser microphone.
- Sensitivity:	1 V. / 600 ohms.
- Frequency response:	De 80 to 18Khz .
- Distortion (THD):	<1%.
- Voltage range:	230VAC / 24VDC.
- Power consumption:	10 W.
- Weight:	960 gr.

FRONT PANEL



- ① — Microphone.
- ② — VU meter indicator.
- ③ — Zone selection keys.
- ④ — Talk button.
- ⑤ — All-Call button.
- ⑥ — POWER indicator.
- ⑦ — CHIME selection key.

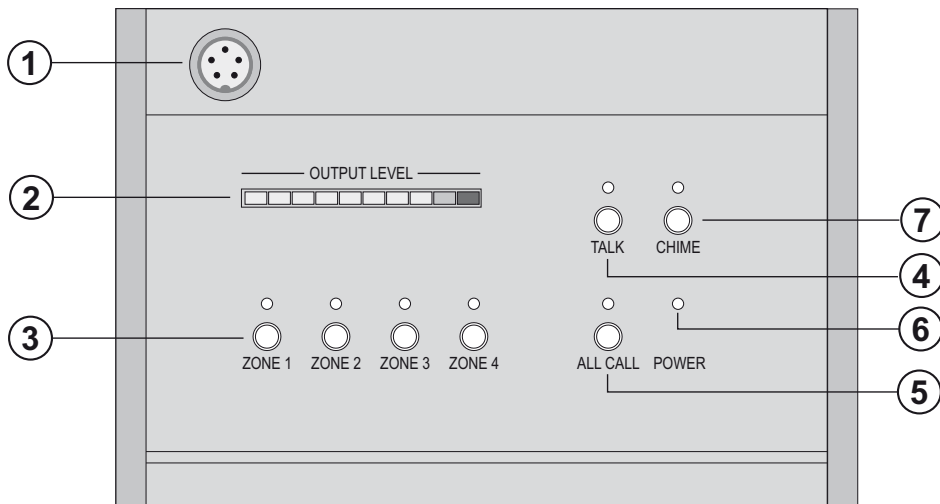

REAR PANEL

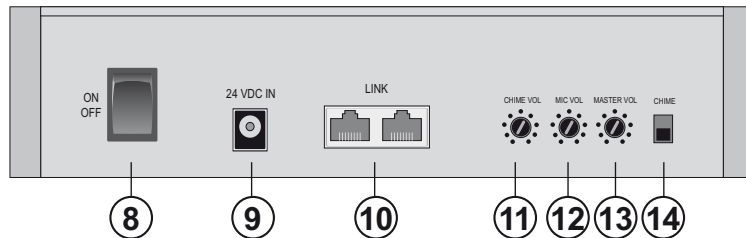

- ⑧ — Power switch.
- ⑨ — 24Vdc input.
- ⑩ — BUS ports.
- ⑪ — Chime volume control.
- ⑫ — Microphone volume control.
- ⑬ — Master volume control.
- ⑭ — Chime selector (2 or 4 tones).

INSTALLATION

CONNECTION TO MXA-400

The first PZ-400 paging desk should be connected with a FTP CAT-5 bus to the MXA-400, in a point to point connection. In case of more than one paging desk in the installation, the other PZ-400 might be connected in a daisy-chaining topology, the amount of meters from the last paging desk until the matrix (MXA-400) cannot be more than 1000 meters (including intermediate PZ-400).

Caution! In connection operation time, remove the power supply.

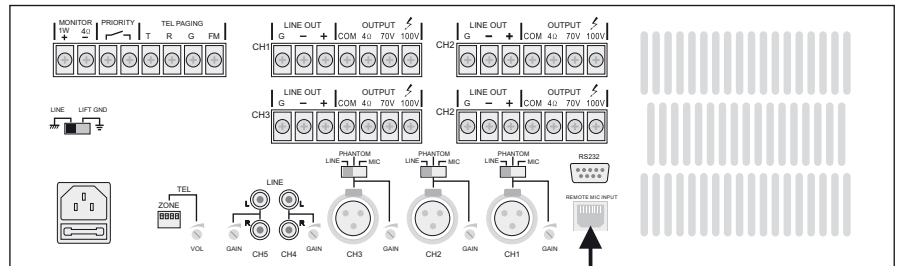

MXA-400

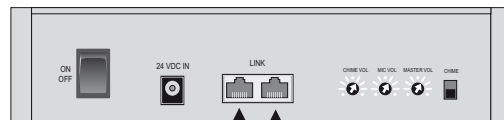

PZ-400 (1)

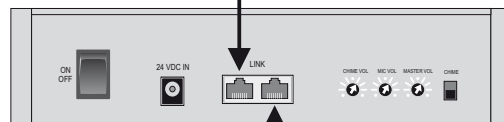

PZ-400 (2)

Maximun:
4 paging desk PZ-400

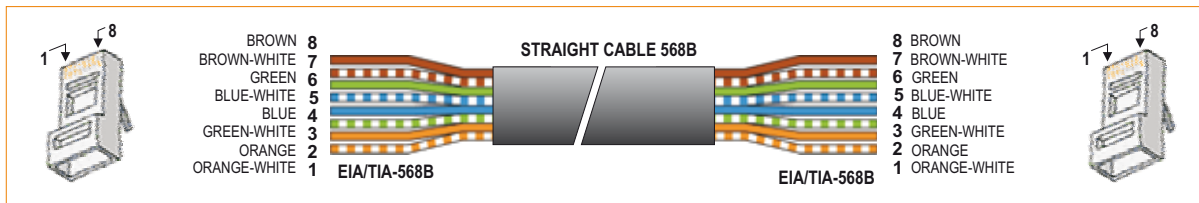

POWER SUPPLY.

PZ-400 can only be supplied with a AC/DC power supply (included).

Switch on the equipment and the frontal LED indicator POWER (blue) and the goose neck microphone LED (red) will turn on.

Caution! The electrical power supply must be 100 - 230 VAC - 50/60 Hz, on the contrary the paging desk might have electrical damages.

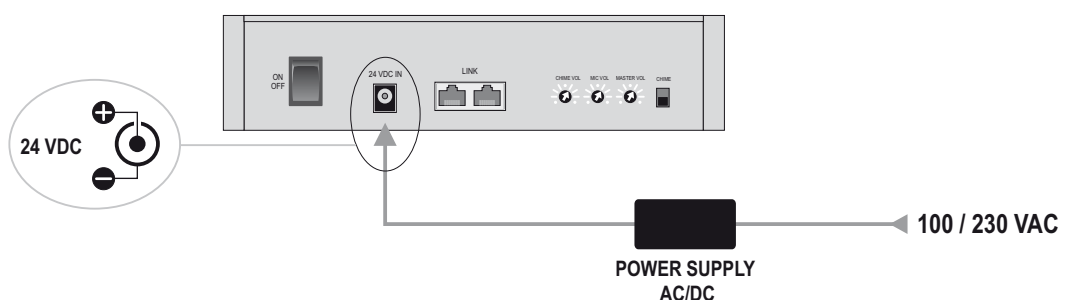

AUDIO CONFIGURATION

CHIME SELECTION.

PZ-400 paging desk has 2 pre-recorded melodies for broadcast before the voice announcement. The chime can be selected in the rear panel.

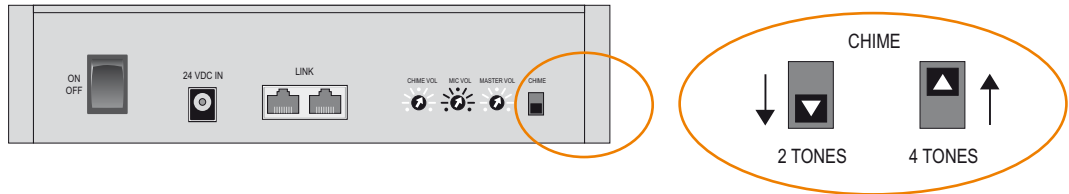

VOLUME ADJUSTMENTS

3 potentiometers in the rear panel allows to:

- Adjust chime volume.
- Adjust microphone volume.
- Adjust master volume (chime/microphone)

The VU meter indicator in the frontal panel displays a representation of the microphone signal level giving information in the volume adjustment process.

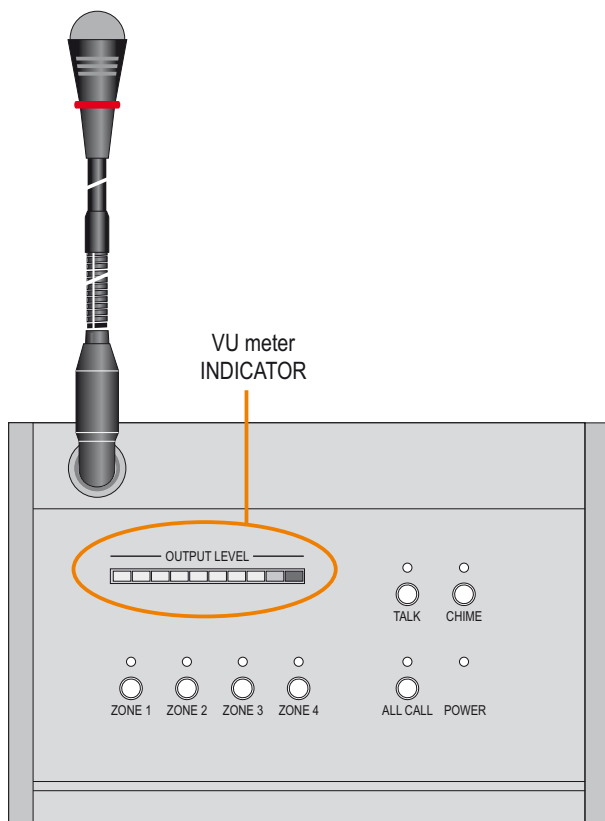

Note:

Remember in the MXA-400 exists more volume controls.

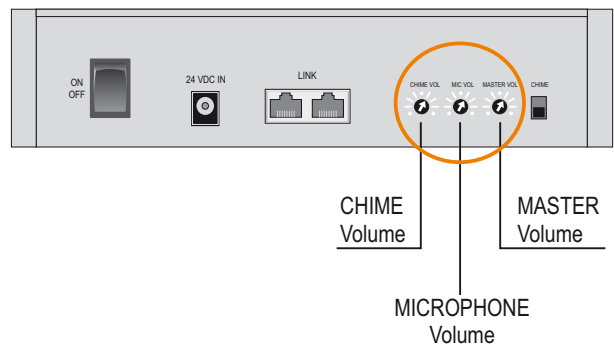

EXAMPLE OF 1 PAGING DESK UTILIZATION

Example: Send a voice announcement to zone 3:

- 1** Press the "Zone 3" selection key and a red LED indicator will turn on.
- 2** If chime option wants to be used, press "CHIME" key on the front panel and a LED indicator will turn on. On the contrary go to point number 3.
- 3** Press the "TALK" button and a green LED indicator on the front panel and a green LED indicator in the gooseneck will turn on, showing the system is ready to use.

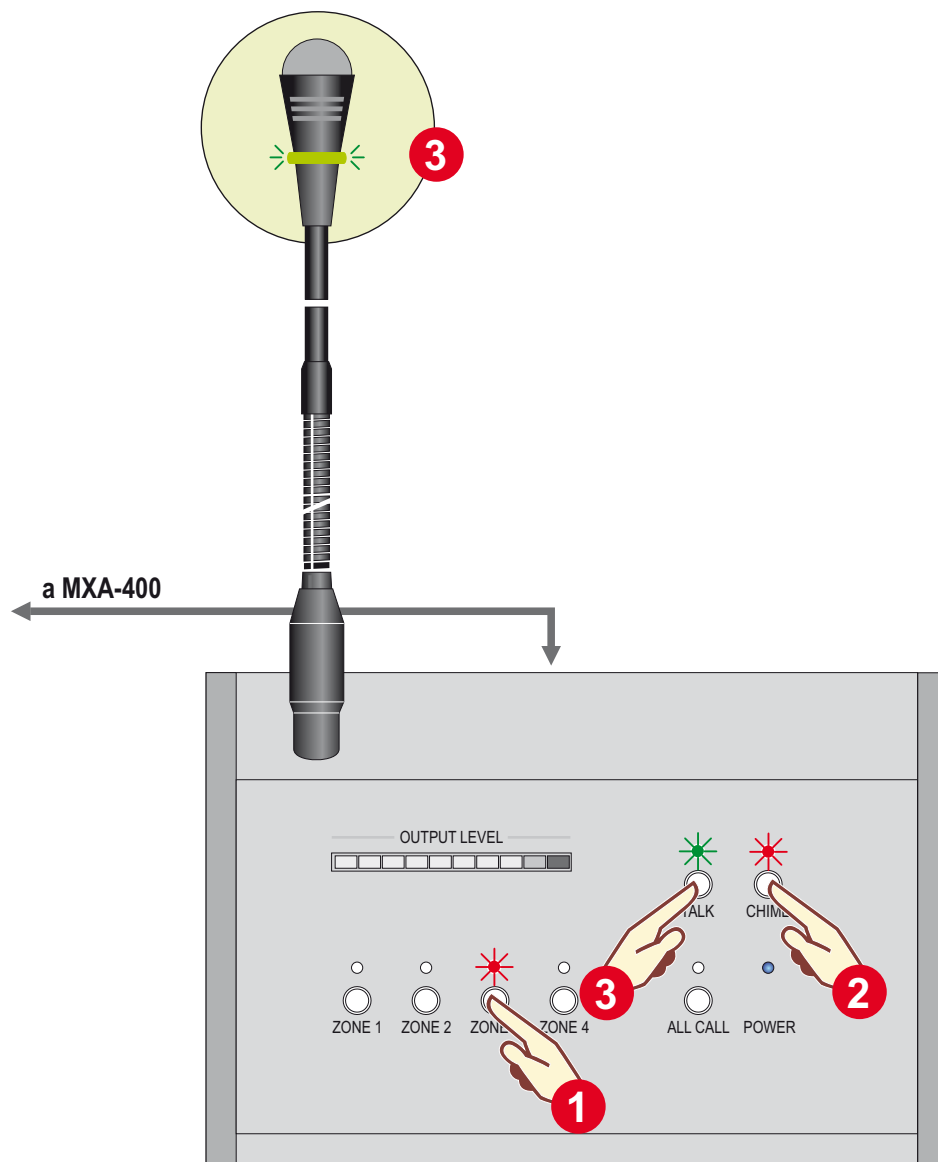

Note: The system will finish an announcement, if there is no microphone modulation in one minute or less.

EXAMPLE OF 2 PAGING DESK UTILIZATION

Until 4 PZ-400 paging desks could be connected to a MXA-400, but only one paging desk can be used at the same time. In case than 2 or more paging desks try to broadcast announcements at the same time the system will show the non possibility of use to the paging desks showing a flashing red LED "TALK" indicator and the only paging desk available to be used will turn on a green LED indicator in the gooseneck and a green "TALK" LED indicator in the frontal panel.

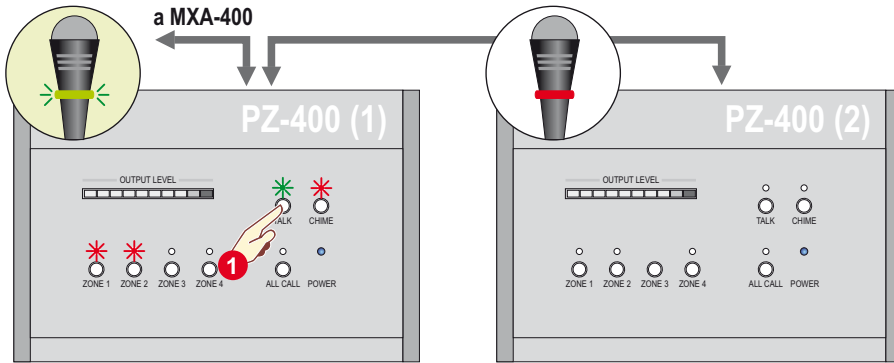

1 User 1 press 1 and 2 zone keys, with chime option and begins to broadcast a voice message. User 2 does not do any selection on his PZ-400 (2).

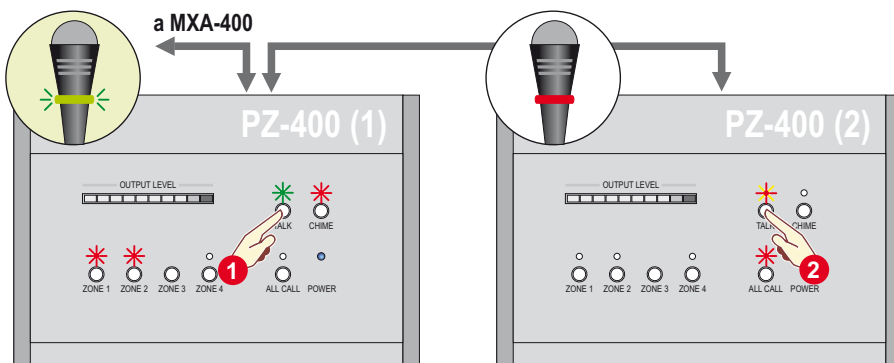

2 User 1 still broadcast the voice message to zones 1 and 2, user 2 press all-call button and press "TALK". User 2 has a busy system indication with a flashing red LED "TALK", notifying the system is not ready to process more calls, due the PZ-400 (1) is still broadcasting a message.

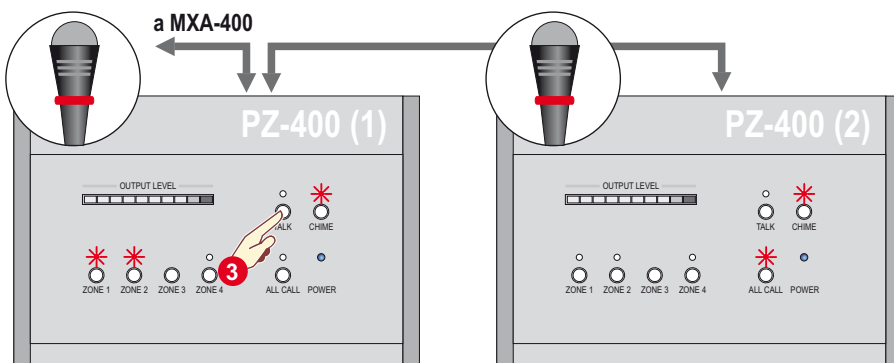

3 User 1 finish the voice message and press "TALK", in the same time the PZ-400 (2) stops to flash the red indicator.

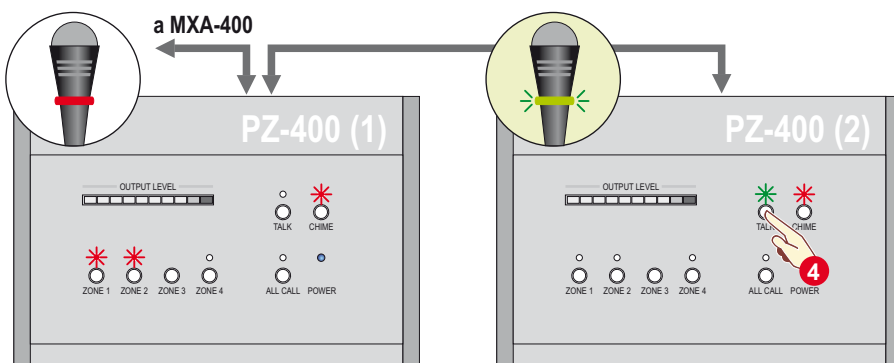

4 User 2 should press another time the "TALK" button being able to send the voice message to all zones.

Note: The system will finish a voice message and will release all flashing LEDs busy indicators, if there is no microphone modulation in one minute or less.